

# Safety safe your life

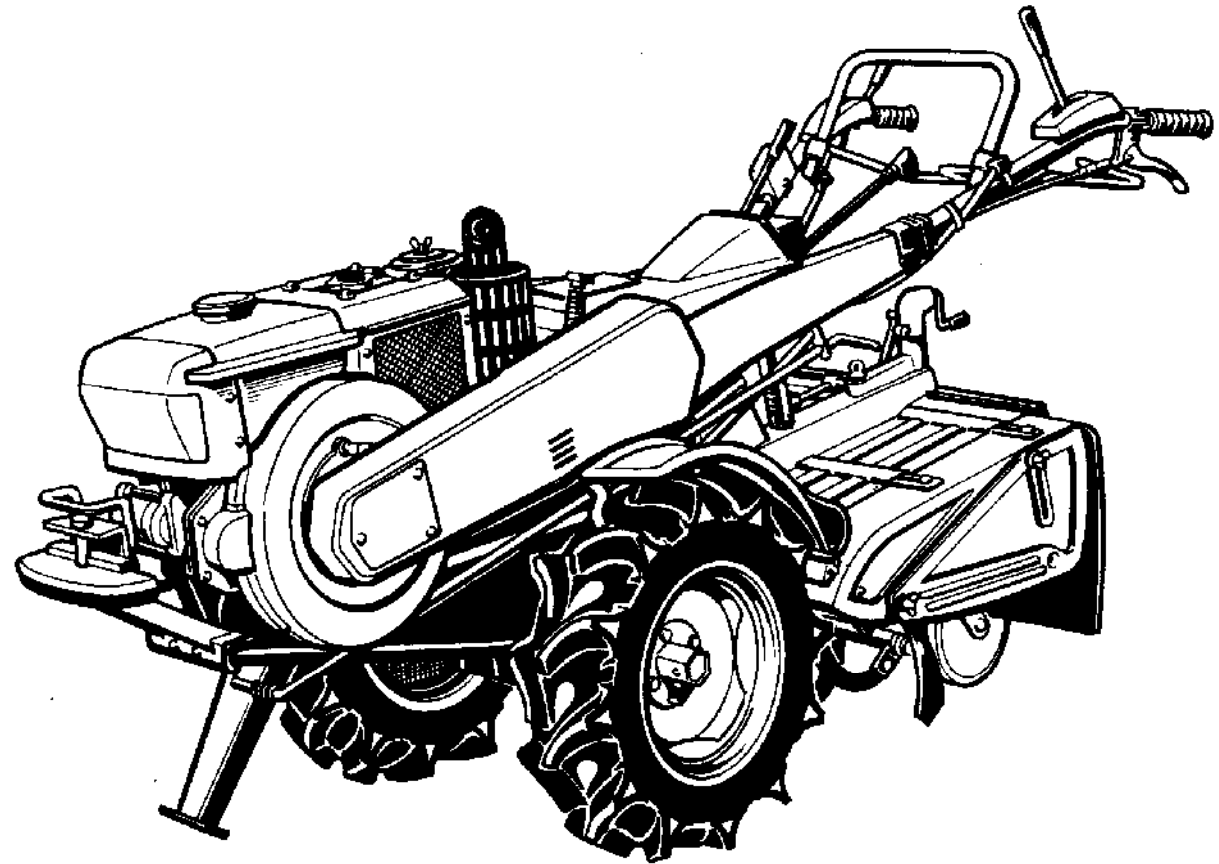

I 1325

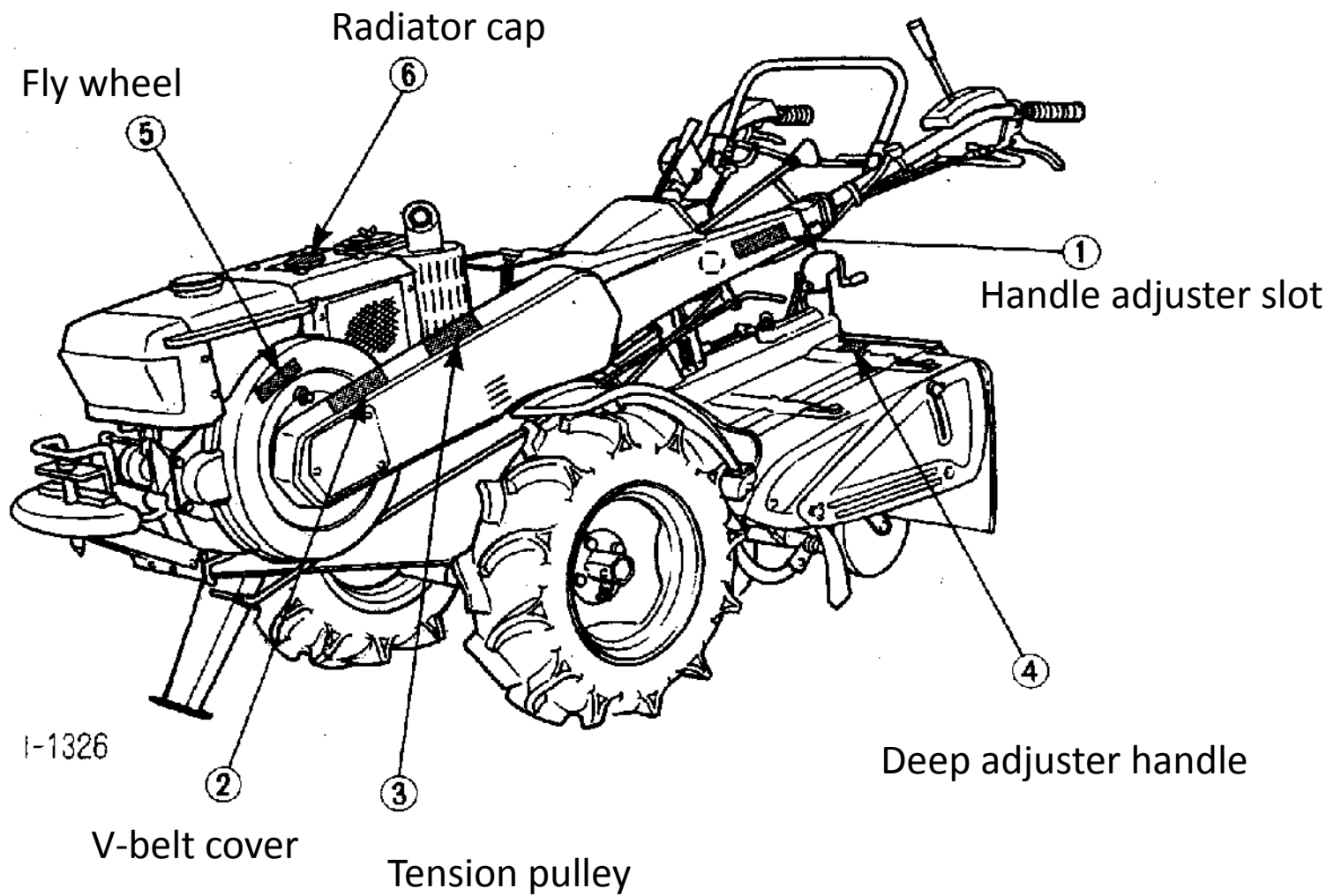

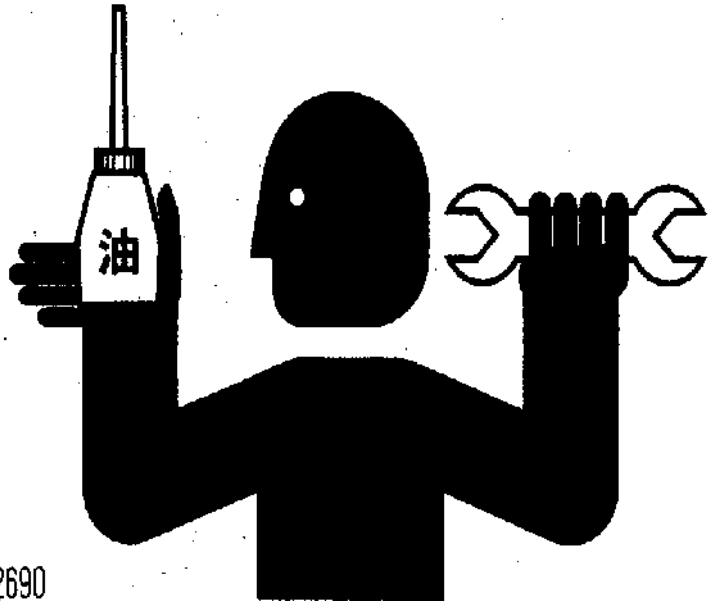

2690

Prepare yourself for any check up  
before you start the engine.

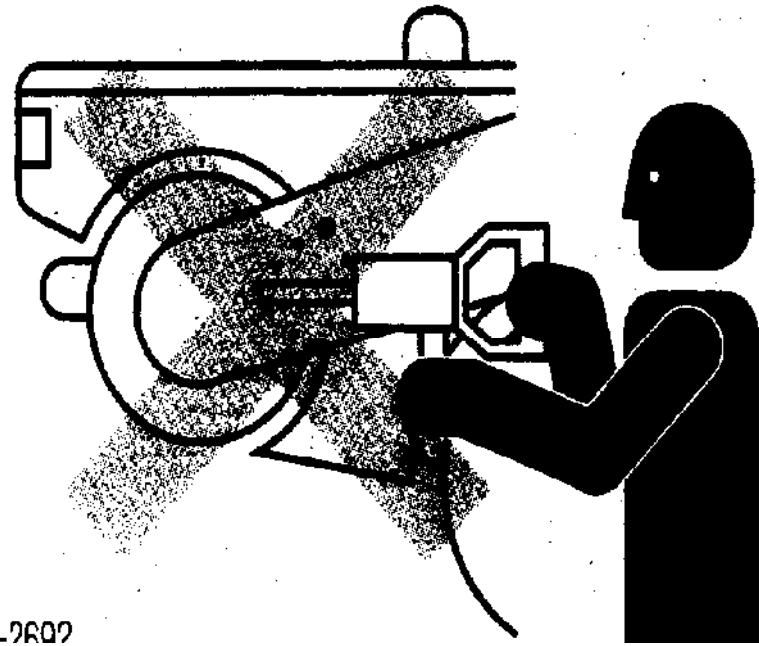

1-7R07

Caution please



Beware, always stop to check the belts.

Please stop the engine or else you must do the necessary checking and maintenance before you attempt to start the engine.

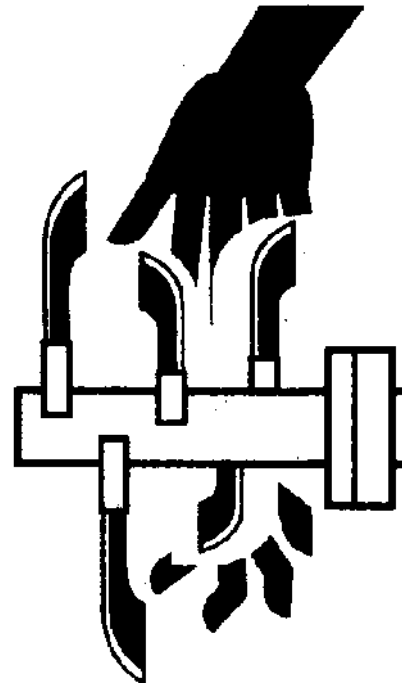

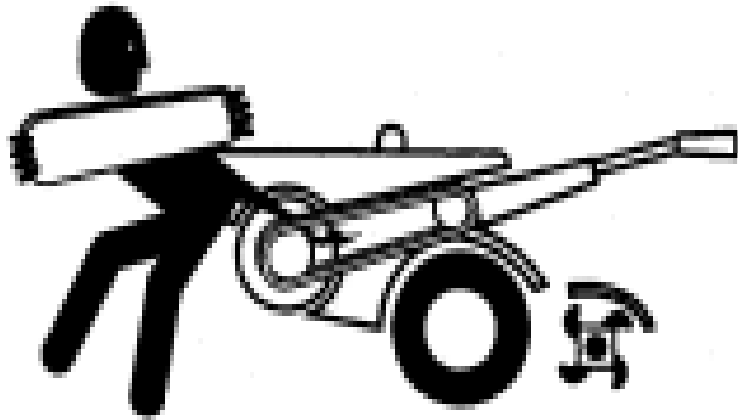

Do not cover the V-belt while the engine is running. This will always injure you any time

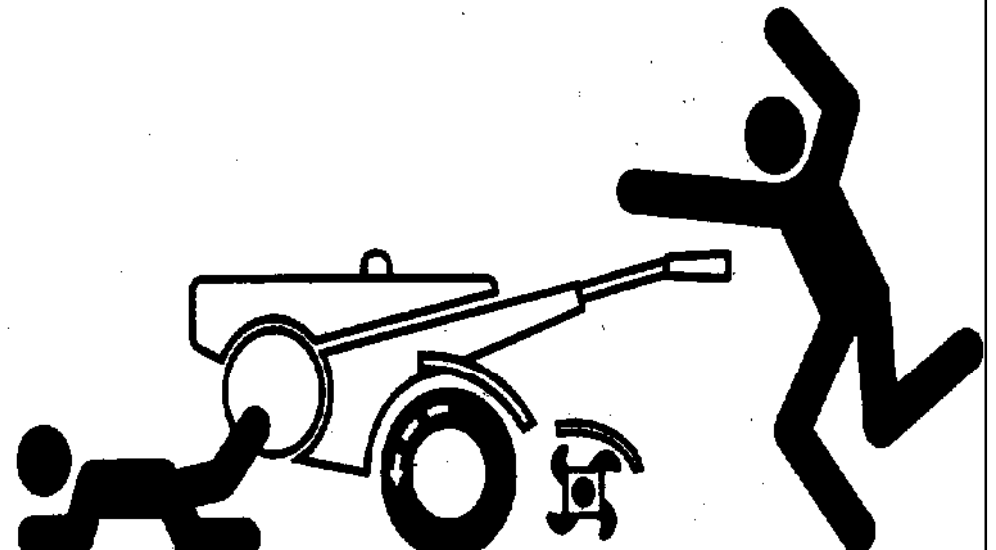

Before you move with the machine always check to see around if any object is hindering you

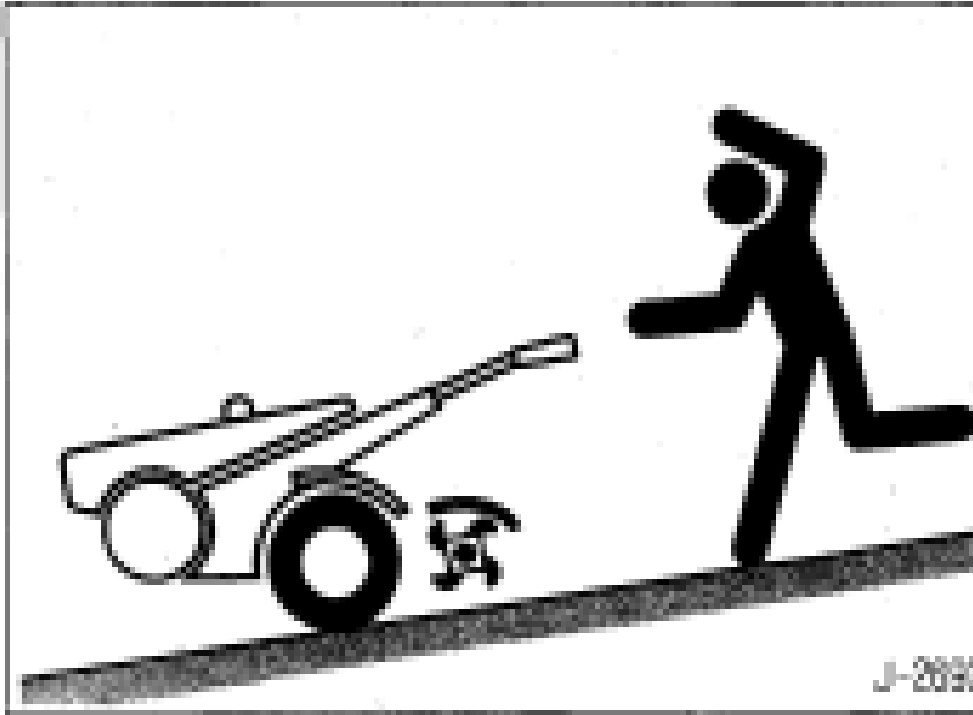

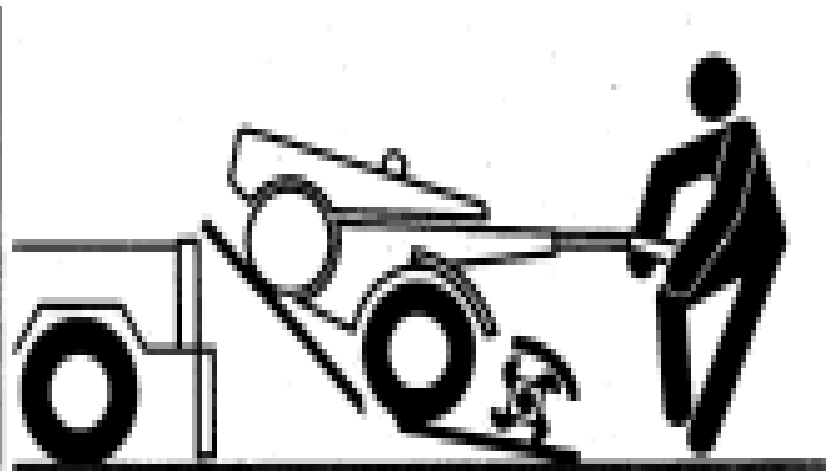

Climbing Transporting machines

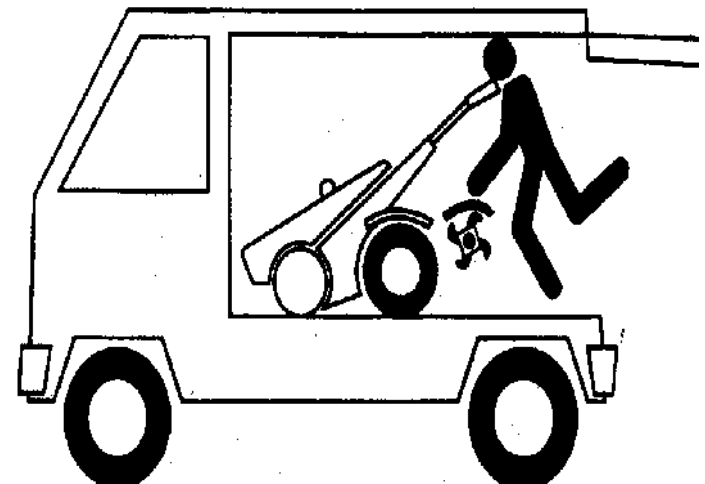

Transporting machine

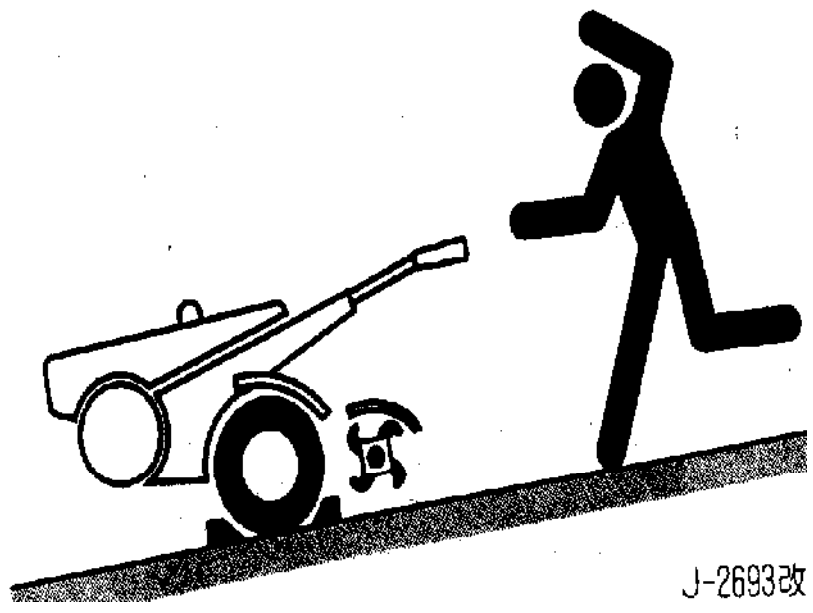

J-2693改

Do not drive front in slope with implements attached

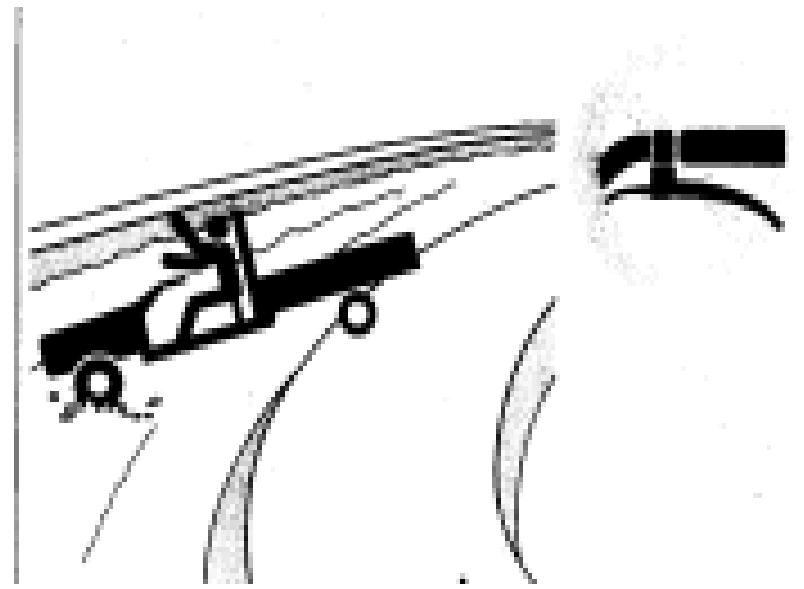

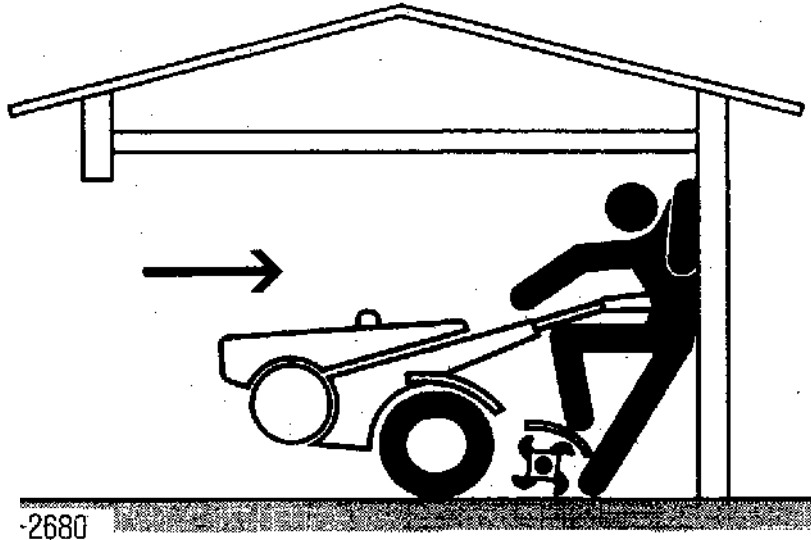
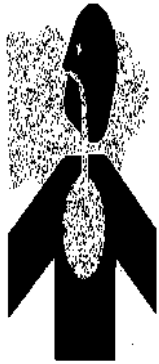

Caution be alert always

Do not start the engine inside store or House, "smoke is injuries to health"

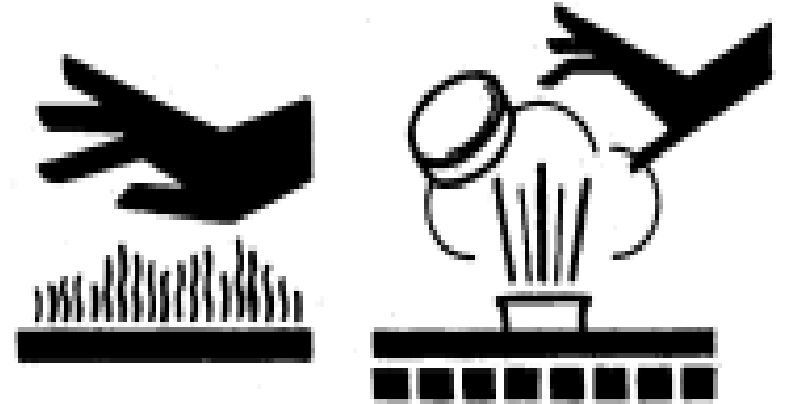

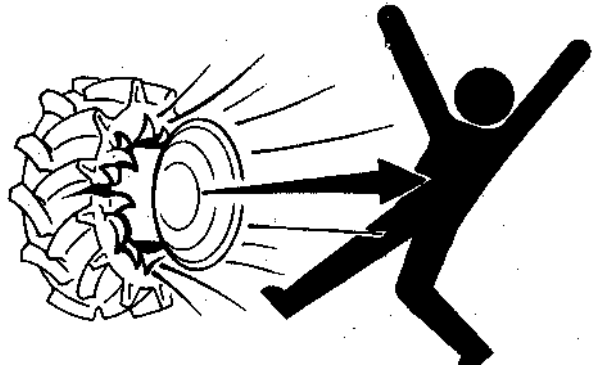

Check the tire pressure



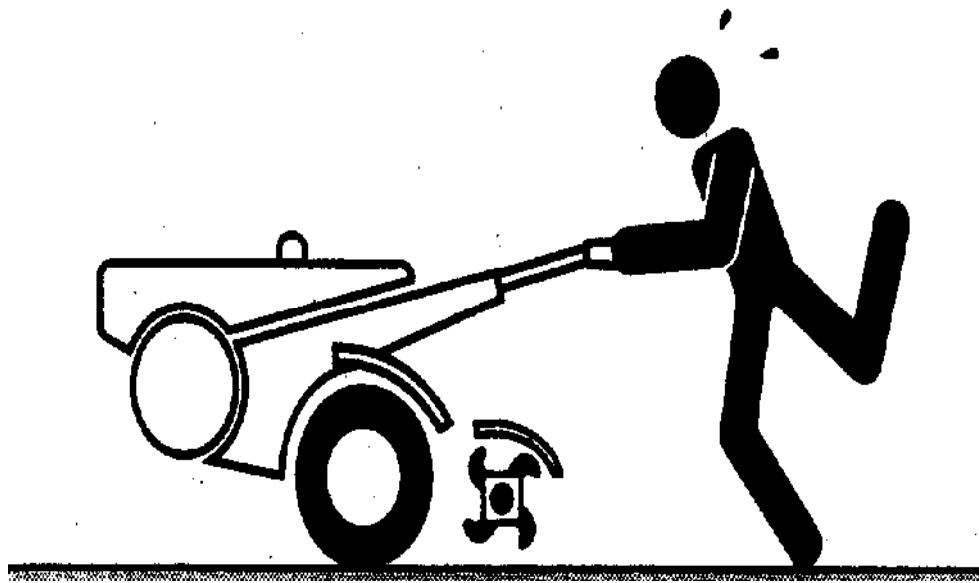

Out of control "speed limit"